

Specification Status: Released

Electrical Rating

Voltage: 16V_{DC} MAX
Current: 100A MAX

Insulating Material:

Cured, Flame Retardant Epoxy Polymer
 meets UL94 V-0 Requirements

Lead Material:

20 AWG Tin Plated Copper
 (0.8 mm [0.032] nom. diameter)

Marking:

- Raychem Logo and Voltage
- XX 16
- Part Identification
- HF8
- Lot Identification (can be on back)
- □ □ □

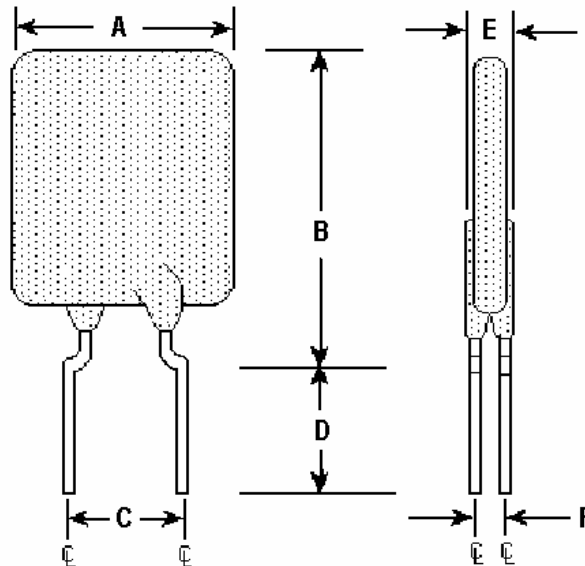

TABLE I. DIMENSIONS:

	A		B		C		D		E		F
	MIN	MAX	MIN	MAX	MIN	MAX	MIN	MAX	MIN	MAX	TYP
mm:	--	16.5	--	22.5	4.3	5.8	7.6	--	--	3	1.2
in*:	--	(0.65)	--	(0.88)	(0.17)	(0.23)	(0.3)	--	--	(0.12)	(0.05)

*Rounded off approximation

TABLE II. PERFORMANCE RATINGS:

I HOLD RATED CURRENT	CURRENT RATINGS		TIME TO TRIP	INITIAL RESISTANCE VALUES		ONE-HOUR POST-TRIP RESISTANCE STANDARD TRIP	NOMINAL TRIPPED POWER DISSIPATION
	AMPS AT 25°C HOLD	AMPS AT 25°C HOLD TRIP	SECONDS AT 25°C, 40A MAX	OHMS AT 25°C MIN	OHMS AT 25°C MAX	OHMS AT 25°C MAX	WATTS AT 25°C 16V TYP
8.0	8.0	15.0	8.0	0.008	0.0135	0.020	4.2

Agency Recognitions:
 Reference Documents:
 Precedence:
 Effectivity:
 CAUTION:

UL, CSA, TUV.
 PS300
 This specification takes precedence over documents referenced herein.
 Reference documents shall be the issue in effect on the date of invitation for bid.
 Operation beyond the rated voltage or current may result in rupture, electrical arcing or flame.

Materials Information

ROHS Compliant

ELV Compliant

Pb-Free

Directive 2002/95/EC
 Compliant

Directive 2000/53/EC
 Compliant

